

VERSION ONE AUTOIMPORT  
NAVIGATOR 150CC



JSD250T-8

FUEL TANK ASSY



	Code	Description	Qty	Price
1	JSD250T-8-048	TANK BODY	1	22.00
2	JSD250T-8-049	BRACKET. FUEL TANK	1	14.00
3	JSD250T-8-050	LID FUEL TANK	1	3.00
4	JSD250T-8-051	PRESSURE BOARD	1	1.00
5	JSD250T-8-052	SENSOR	1	3.50
6	JSD250T-8-053	FUEL LOCK	1	13.00
7	JSD250T-8-054	PLPE FUEL	3	2.30
8	JSD250T-8-055	TUBE VACCUM BALANCE	1	2.30
9	JSD250T-8-056	FILTER	1	1.50

BODY FRAME



	Code	Description	Qty	Price
1	JSD250T-8-004	BODY FRAME	1	160.00

WIRE ASSY



	Code	Description	Qty	Price
1	JSD250T-8-112	HARNESS, WIRING	1	26.00
2	JSD250T-8-113	High tension bag	1	10.00
3	JSD250T-8-114	STARER RELAY	1	6.00
4	JSD250T-8-115	HORN COMP (HIGH)	1	4.00
5	JSD250T-8-116	WIRING	1	12.00
6	JSD250T-8-117	CLAMP	10	0.20
7				
8	JSD250T-8-119	CDI NUIT	1	10.00
9	JSD250T-8-120	REGULATOR N.	1	12.00
10	JSD250T-8-121	BATTERY ASSY	1	46.00
11	JSD250T-8-122	LOCK ASSY	1	18.00

REAR SIDE DEFENDER、 WIND DEFENDER、 REAR LACQURE

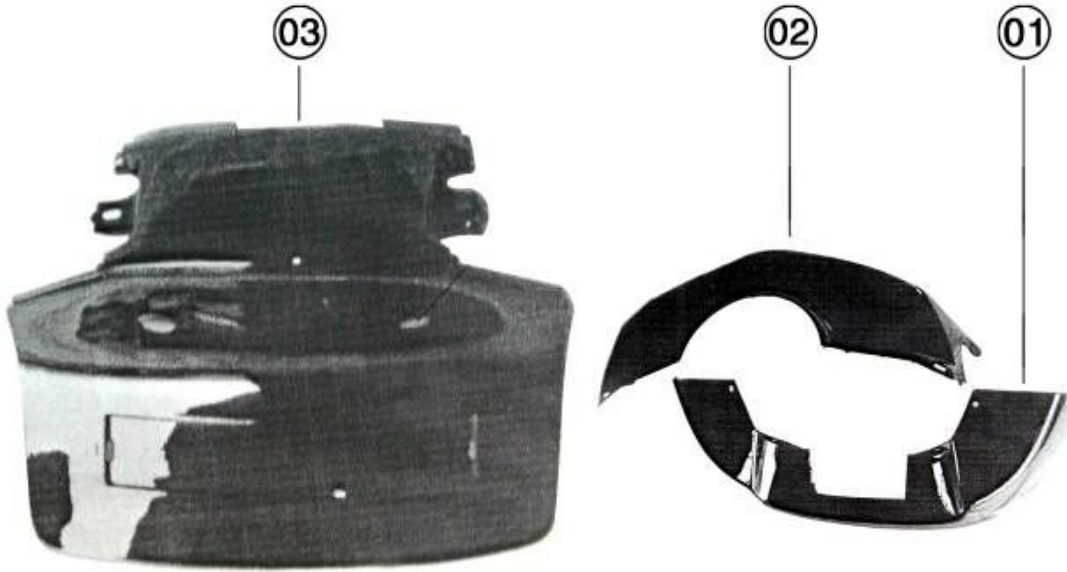

	Code	Description	Qty	Price
1	JSD250T-8-001	REAR SIDE DEFENDER	1	4.50
2	JSD250T-8-002	WIND DEFENDER	1	10.00
3	JSD250T-8-003	REAR COVER. TALL	1	6.00

LACQUIRE PARTS, L/R



	Code	Description	Qty	Price
1	JSD250T-8-016	LEFT COVER, REAR	1	17.00
2	JSD250T-8-017	RIGHT COVER, REAR	1	17.00

REAR ABSORBER ASSY

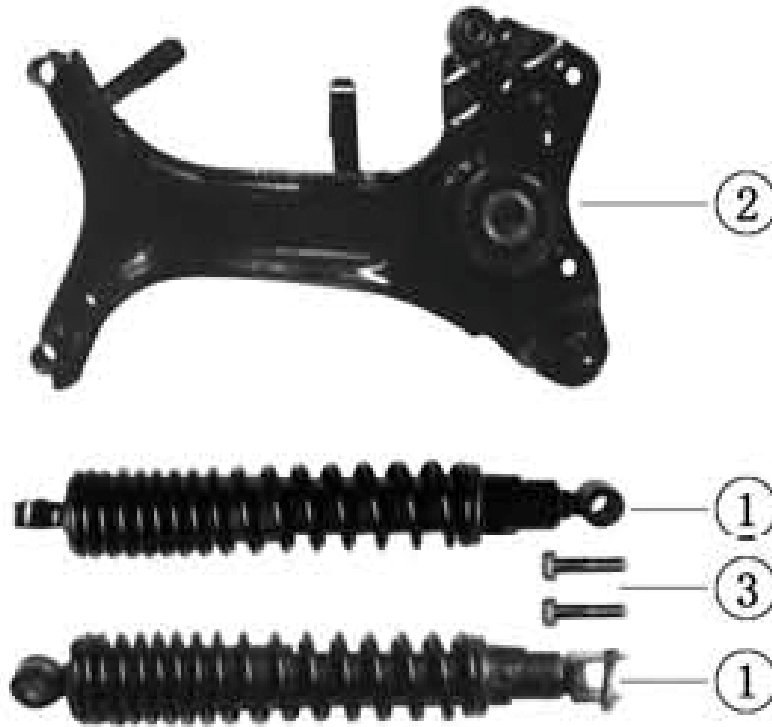

	Code	Description	Qty	Price
1	JSD250T-8-045	REAR ABSORBER	2	16.00
2	JSD250T-8-046	REAR ABSORBER POSITION	1	18.00
3	JSD250T-8-047	BOLT	2	1.00

SEAT、SPEEDOMETER ASSY



	Code	Description	Qty	Price
1	JSD250T-8-069	SEAT	1	46.00
2	JSD250T-8-070	SWINCH	6	5.00
3	JSD250T-8-071	SPEEDOMETER COVER	1	7.00

# HEADLAMP

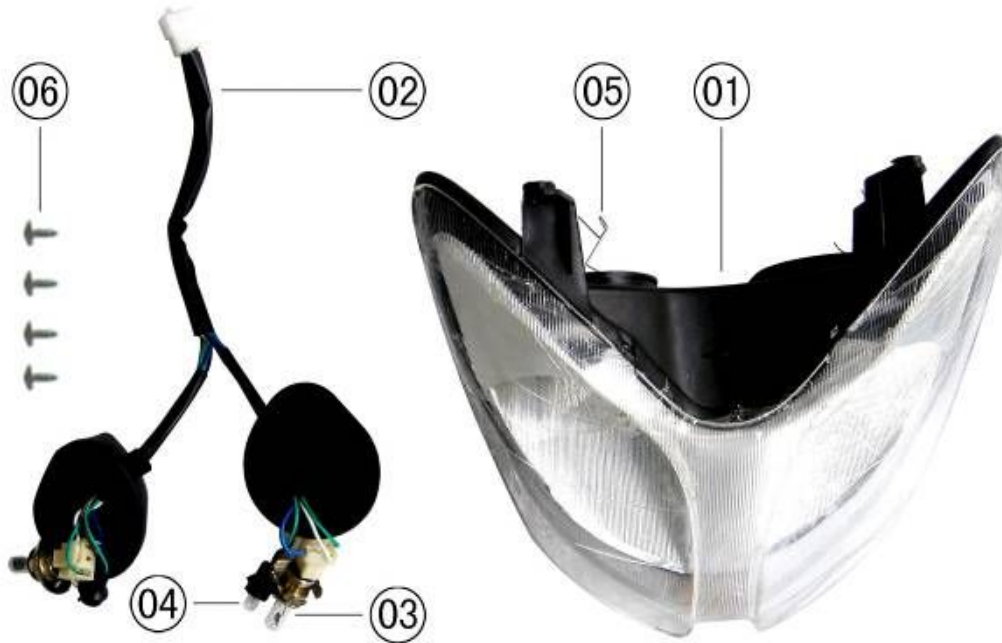

	Code	Description	Qty	Price
1	JSD250T-8-101	HEADLAMP. COVER	1	45.00
2	JSD250T-8-102	WIER. HEADLAMP	1	
3	JSD250T-8-103	BULB. HEADLAMP	2	
4	JSD250T-8-104	SMALL BULB. HEADLAPM	2	
5	JSD250T-8-105	CIRLIP	1	
6	GB845-ST4. 2 " 16	SCREW	4	0.30

HANDLEBAR、LUGGAGE BOX OUTCOVER

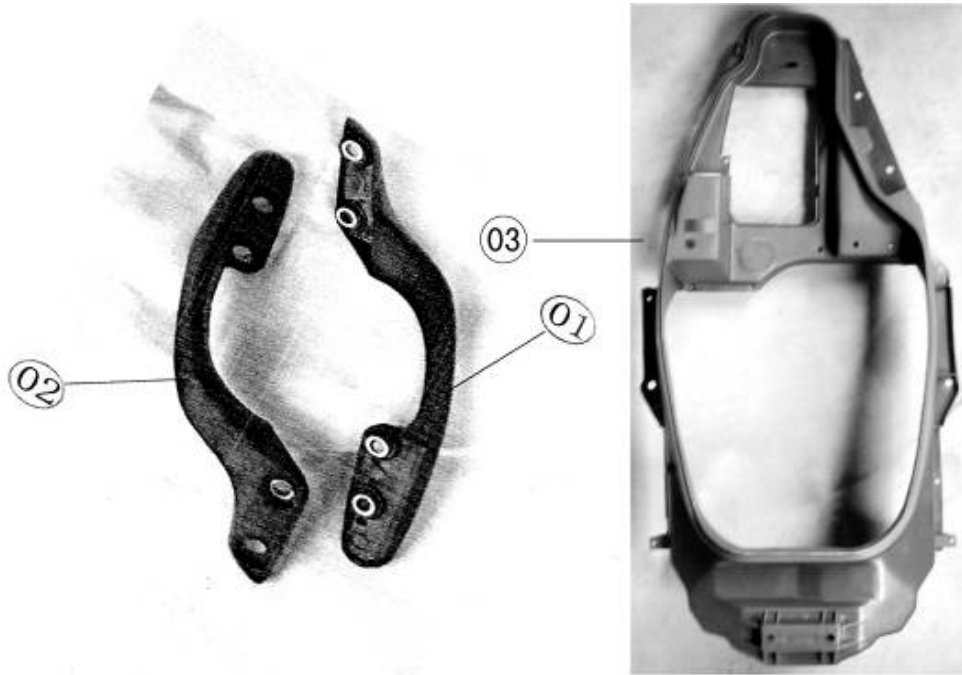

	Code	Description	Qty	Price
1	JSD250T-8-106	L/R HANDLE	1	5.00
2	JSD250T-8-107	R/R HANDLE	1	5.00
3	JSD250T-8-108	LUGGAGE BOX BODY COVER	1	21.00

# SPEEDOMETER

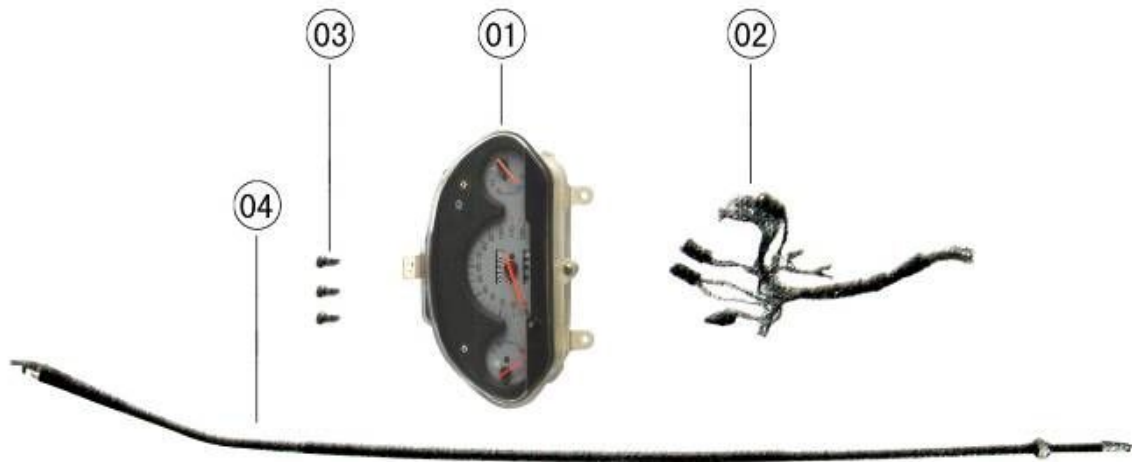

	Code	Description	Qty	Price
1	JSD250T-8-109	Speedometer assy	1	37.00
2	JSD250T-8-110	CABLE. Speedometer assy	1	3.00
3	GB845-ST4.8 `16	SCREW	3	0.30
4	JSD250T-8-111	CABLE ASSY. Speedometer	1	2.00

## FRONT BRAKE MASTER CYLINDER

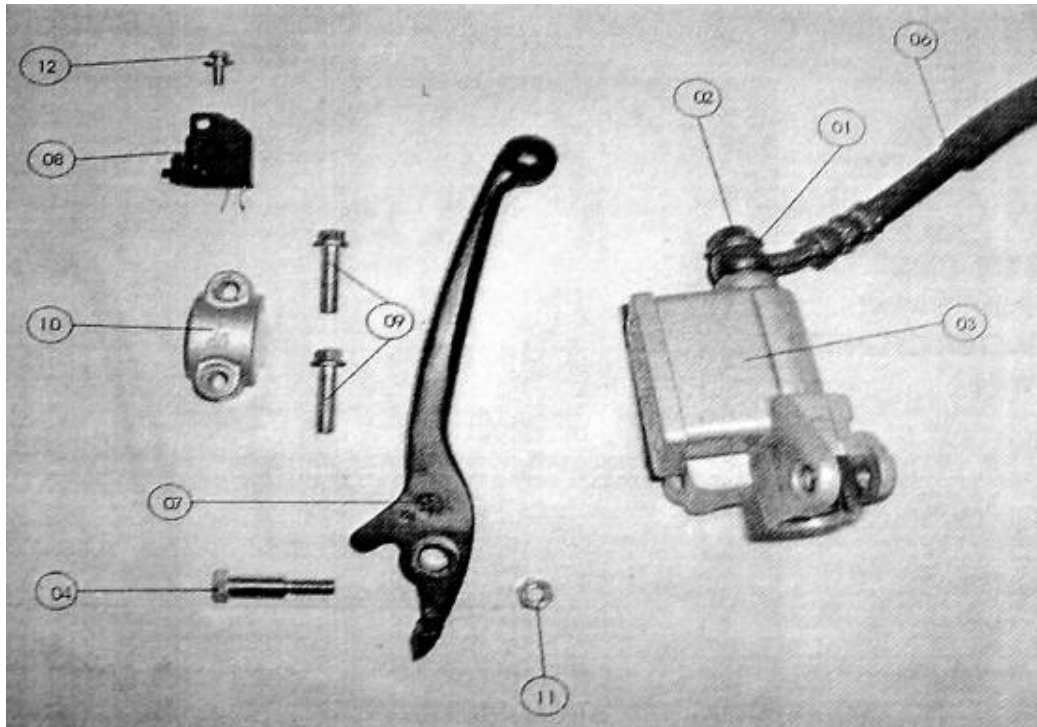

	Code	Description	Qty	Price
1	JSD250T-8-123	WASHER	4	0.60
2	JSD250T-8-124	BOLT	2	1.20
3	JSD250T-8-125	PUMP. MAIN	1	14.00
4	JSD250T-8-126	BOLT	1	1.20
6	JSD250T-8-127	HOSE, FRONT BRAKE	1	9.00
7	JSD250T-8-128	LEVER, FRONT BRAKE	1	3.60
8	JSD250T-8-129	SWITCH ASSY, FRONT BRAKE	1	1.20
9	JSD250T-8-130	Bolt flange	2	0.20
10	JSD250T-8-131	Half circle poiston	1	1.20
11	JSD250T-8-132	Nut	4	0.40
12	JSD250T-8-133	Bolt	1	0.40

# FRONT BRAKE VICE CYLINDER

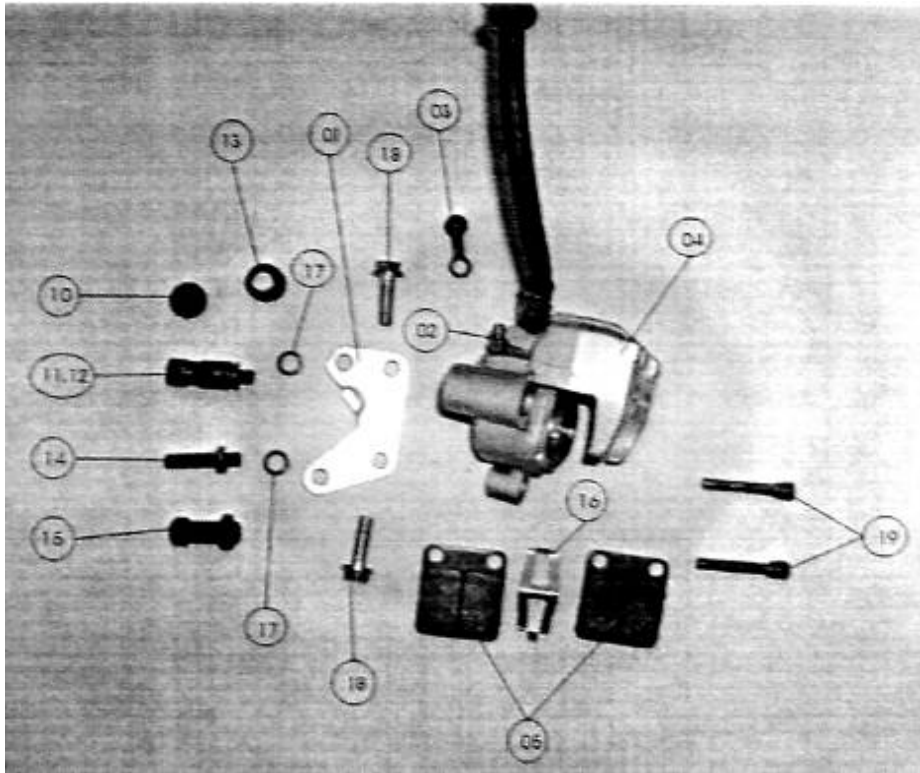

	Code	Description	Qty	Price
1	JSD250T-8-134	CARRIER SET. CALIPERS	1	4.00
2	JSD250T-8-135	BLEEDER	1	1.20
3	JSD250T-8-136	CAP. BLEEDER	1	0.60
4	JSD250T-8-137	PUMP SHELL	1	16.00
6	JSD250T-8-138	PAD SET	1 付	4.00
10	JSD250T-8-139	COVER	1	0.80
11	JSD250T-8-140	BOLT	1	1.20
12	JSD250T-8-141	SLIPPY HOSE	1	1.20
13	JSD250T-8-142	LONG BUSH	1	0.80
14	JSD250T-8-143	SLIPPY SHAFT	1	2.00
15	JSD250T-8-144	CAP. BUSH	1	0.90
16	JSD250T-8-145	SUPPORT PAD	1	1.60
17	JSD250T-8-146	WASHER	2	0.30
18	JSD250T-8-147	BOLT FLANGE	2	0.60
19	JSD250T-8-148	PIN	2	0.90

## REAR BRAKE SETS

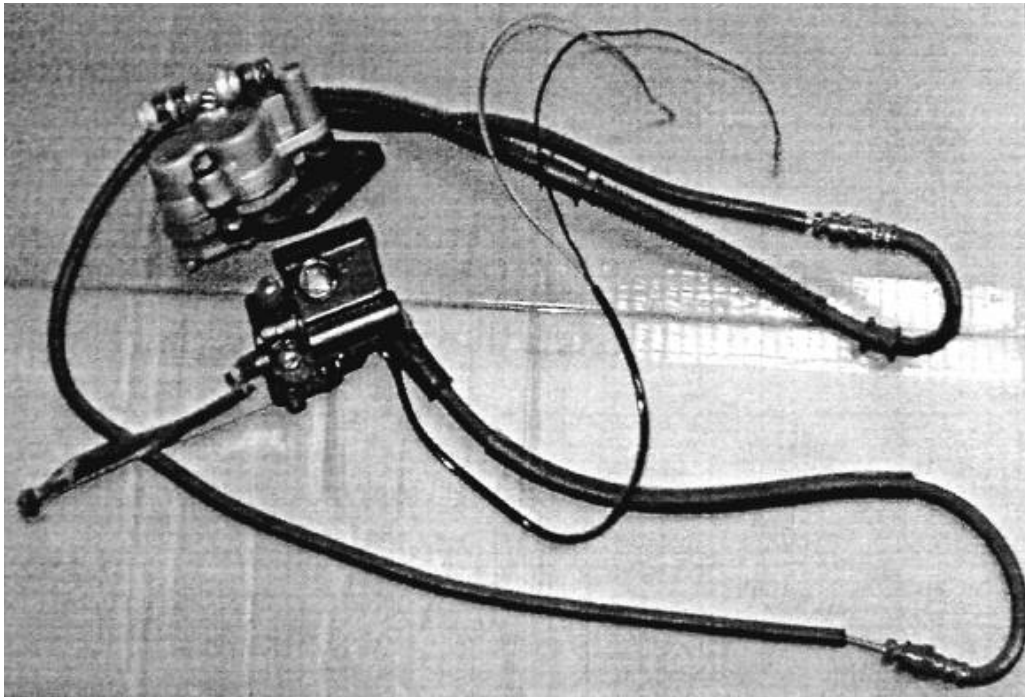

	Code	Description	Qty	Price
1	JSD250T-8-149	REAR BRAKE VICE CYLINER	1	26.00
2	JSD250T-8-150	REAR BRAKE MASTER CYLINER	1	16.00
3	JSD250T-8-151	REAR BRAKE WIRE	1	23.00
4	JSD250T-8-152	RERA BRAKE CABLE	1	0.90

# TRUMPET STANDER/TAIL LAMP

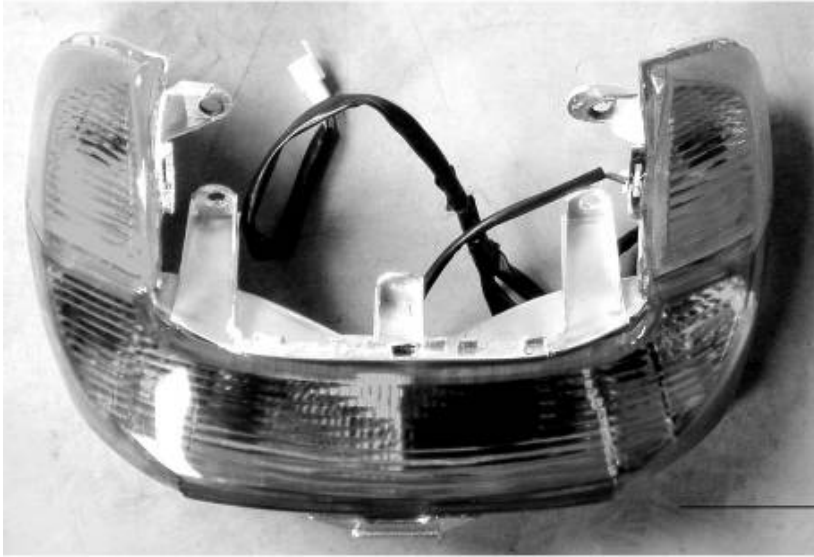

01

02

	Code	Description	Qty	Price
1	JSD250T-8-161	TRUMPET STANDER	1	10.00
2	JSD250T-8-162	TAIL LAMP	1	45.00

REAR WHEEL

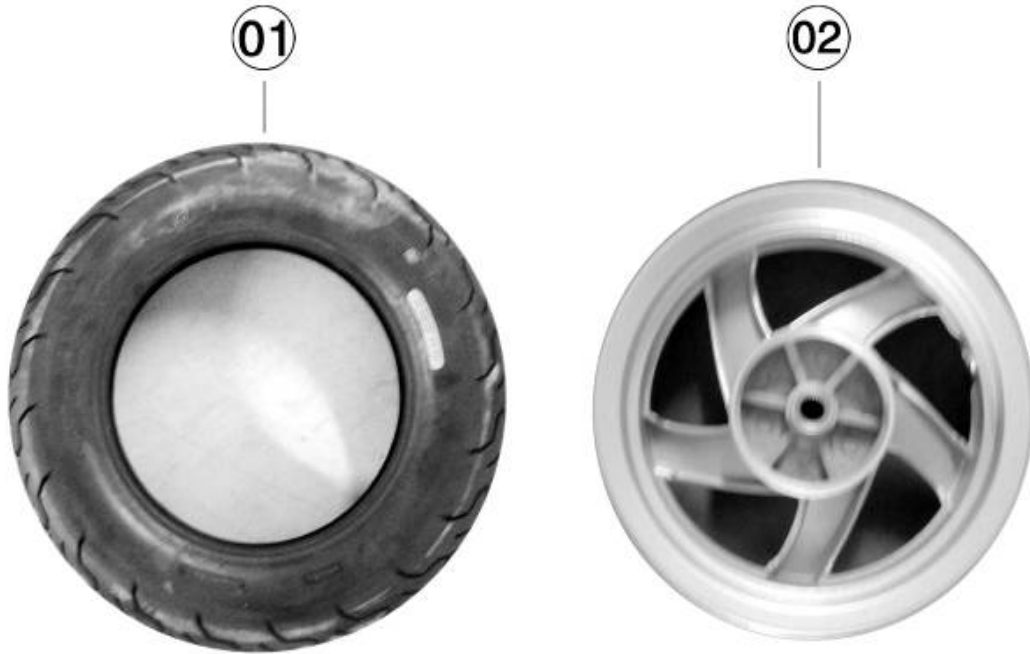

	Code	Description	Qty	Price
1	JSD250T-8-163	REAR TYRE	1	48.00
2	JSD250T-8-164	REAR RING	1	33.00

DEFENDER GLASS . REAR DEFENDER. MARK STANDER

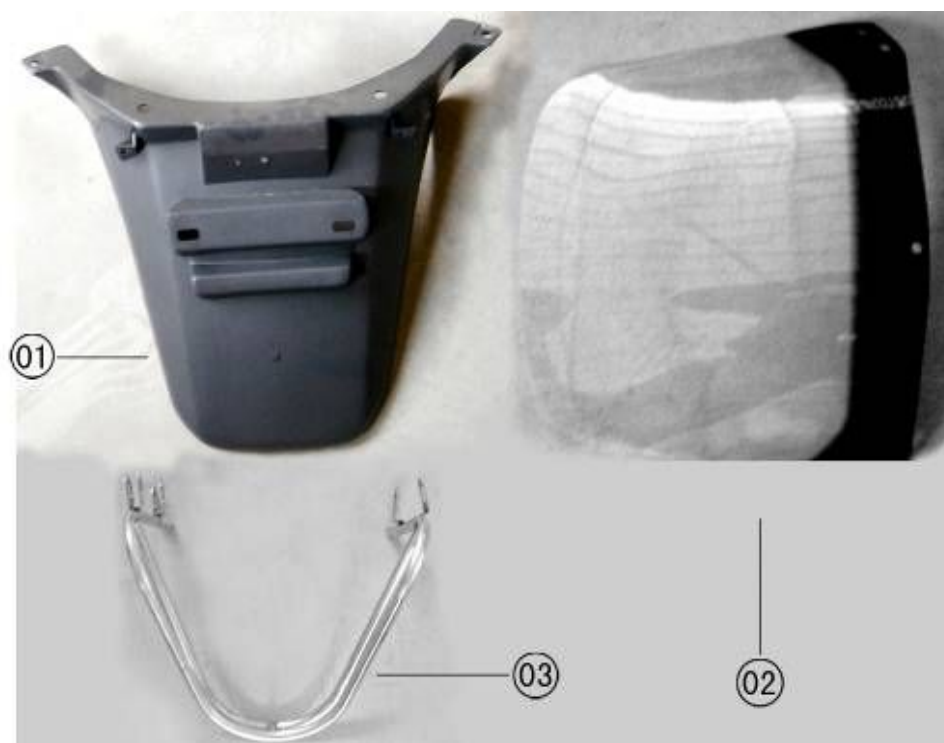

	Code	Description	Qty	Price
1	JSD250T-8-165	REAR DEFENDER	1	3.80
2	JSD250T-8-166	DEFENDER GLASS	1	12.00
3	JSD250T-8-167	MARK STANDER	2	6.00

L/R. FR. TURNING LIGHT. FRONT COVER

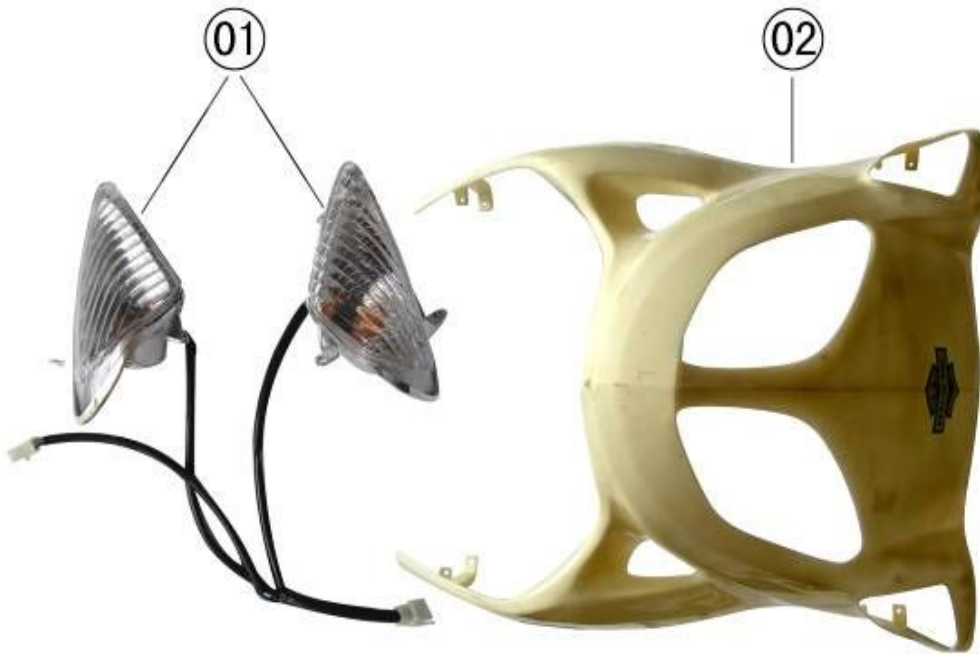

	Code	Description	Qty	Price
1	JSD250T-8-020	L/R. FR. TURNING LIGHT	1	10.00
2	JSD250T-8-021	FRONT COVER	1	19.00

L/R SCOOTER

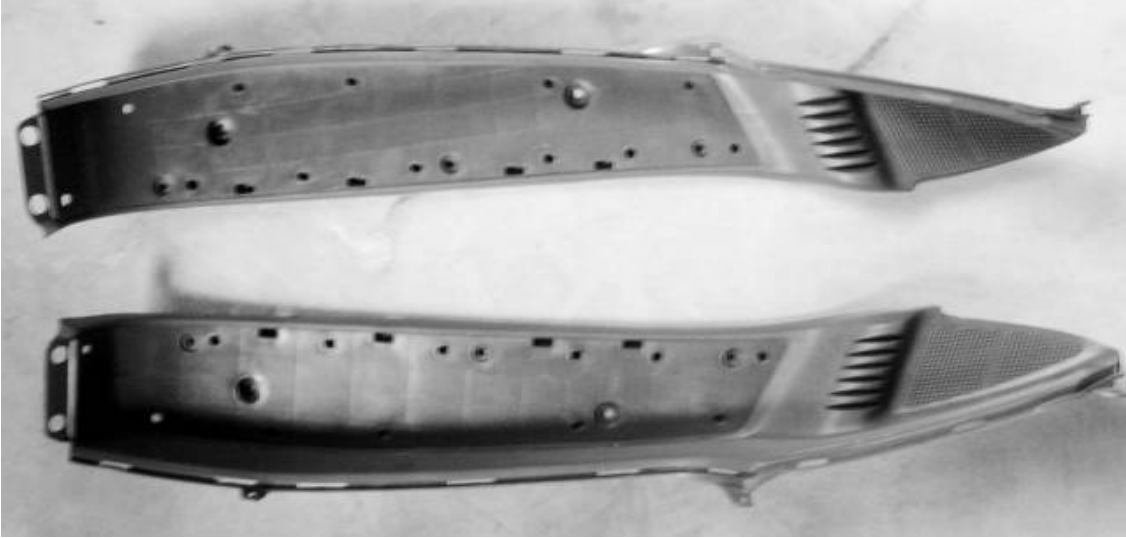

	Code	Description	Qty	Price
1	JSD250T-8-168	L/R SCOOTER	1 付	15.00

Inner luggage box, carburetor, air filter

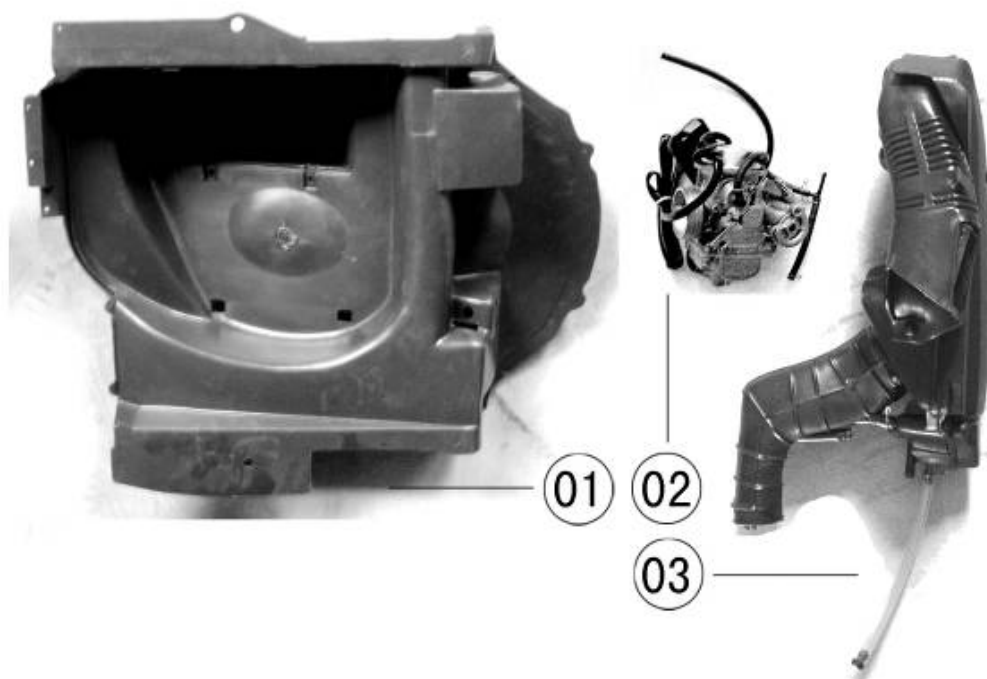

	Code	Description	Qty	Price
1	JSD250T-8-169	Luggage box	1	25.00
2	JSD250T-8-170	Carburetor	1	45.00
3	JSD250T-8-171	Air filter	1	35.00

# Engine



	Code	Description	Qty	Price
1	JSD150T-8-177	Engine	1	650.00

Luggage box, exhaust pipe assy



	Code	Description	Qty	Price
1	JSD250T-8-173	Tool box	1	21.00
2	JSD250T-8-174	Exhaust pipe assy	1	86.00

Tool bag

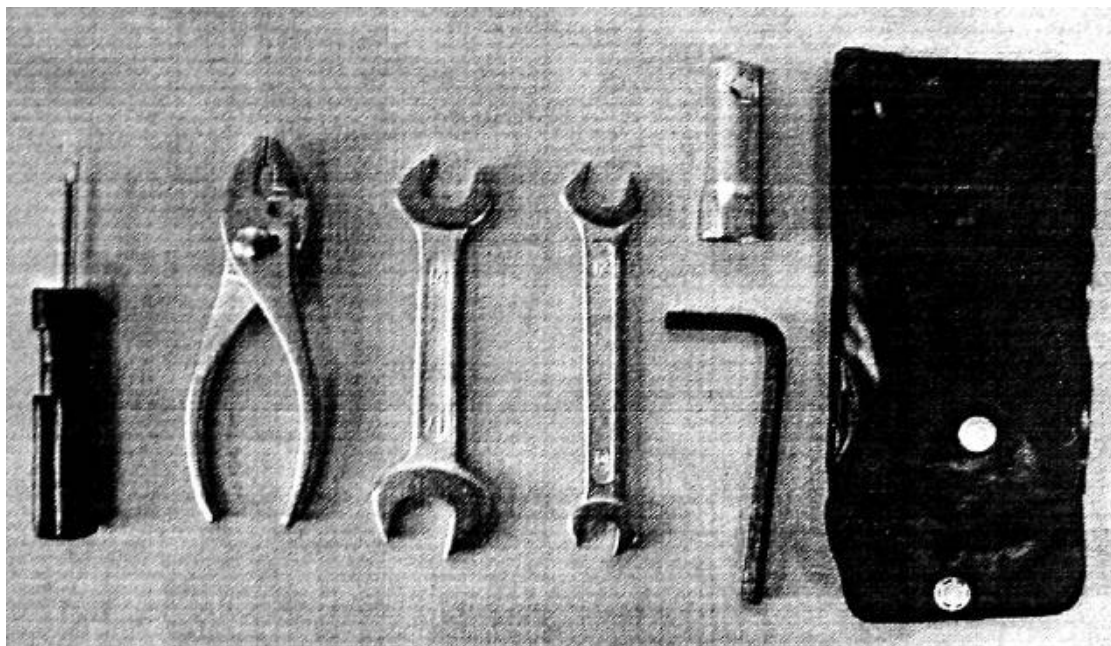

	Code	Description	Qty	Price
1	JSD250T-8-175	Tool set	1	3.00

:Vehicle wheel



	Code	Description	Qty	Price
1	JSD250T-8-072	Tyre	1	48.00
2	JSD250T-8-073	Valve assy, wheel rim	1	1.00
3	JSD250T-8-074	Hub, wheel	1	68.00
4	JSD250T-8-075	Box assy, speedometer	1	5.00
5	JSD250T-8-076	Axle, wheel	1	5.00
6	JSD250T-8-077	Spacer, front wheel	1	1.80
7	JSD250T-8-078	Disk, front brake	1	15.00

Stander、side/center



	Code	Description	Qty	Price
1	JSD250T-8-153	Stander, side	1	5.00
2	JSD250T-8-154	Stander, center	1	15.00

Defender assy



	Code	Description	Qty	Price
1	JSD250T-8-012	Front wheel defender	1	21.00
2	JSD250T-8-013	Front wheel defender rear	1	9.00

Hanger comp engine



	Code	Description	Qty	Price
1	JSD250T-8-008	Hanger comp engine	1	23.00
2	JSD250T-8-009	Lock nut	1	0.90
3	JSD250T-8-010	Axle, engine	1	4.20

Front absorber assy



	Code	Description	Qty	Price
1	JSD250T-8-022	L/F absorber	1	29.00
2	JSD250T-8-023	R/F absorber	1	29.00
3	JSD250T-8-024	Fork stem	1	27.00
4	JSD250T-8-025	Look nut	1	5.00
5	JSD250T-8-026	Dustproof cover	1	
6	JSD250T-8-027	Ball frame assy	2	
7	JSD250T-8-028	Steering race	4	

Handlebar F cover、frame wheel defender

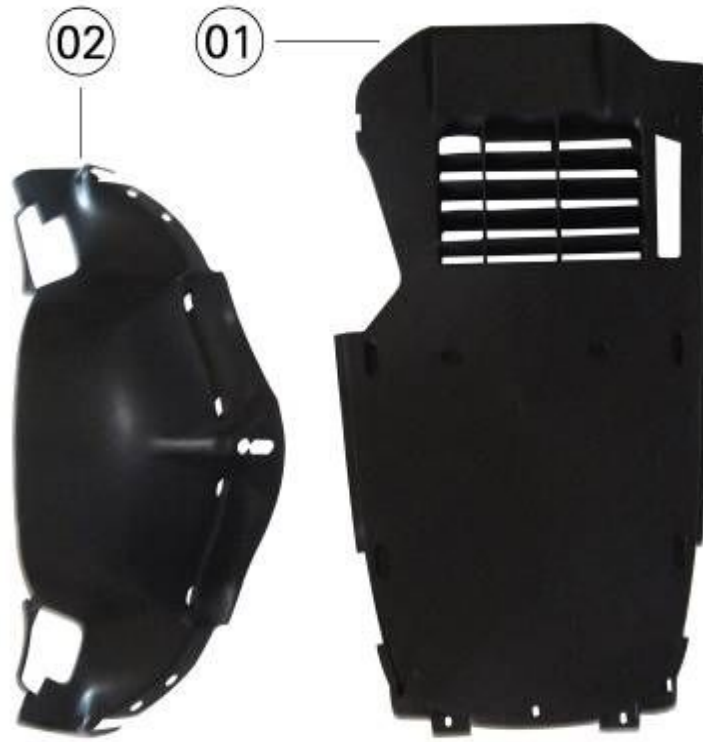

	Code	Description	Qty	Price
1	JSD250T-8-099	Frame wheel defender	1	6.00
2	JSD250T-8-100	Speedometer F cover	1	5.90

Plastic parts



	Code	Description	Qty	Price
1	JSD250T-8-093	Fuel tank mouth cover	1	2.30
2	JSD250T-8-094	Tool box clapboard	1	0.60
3	JSD250T-8-095	Luggage box cover little	1	0.90
4	JSD250T-8-096	Foot floor defender	1	0.80

L/R, defender

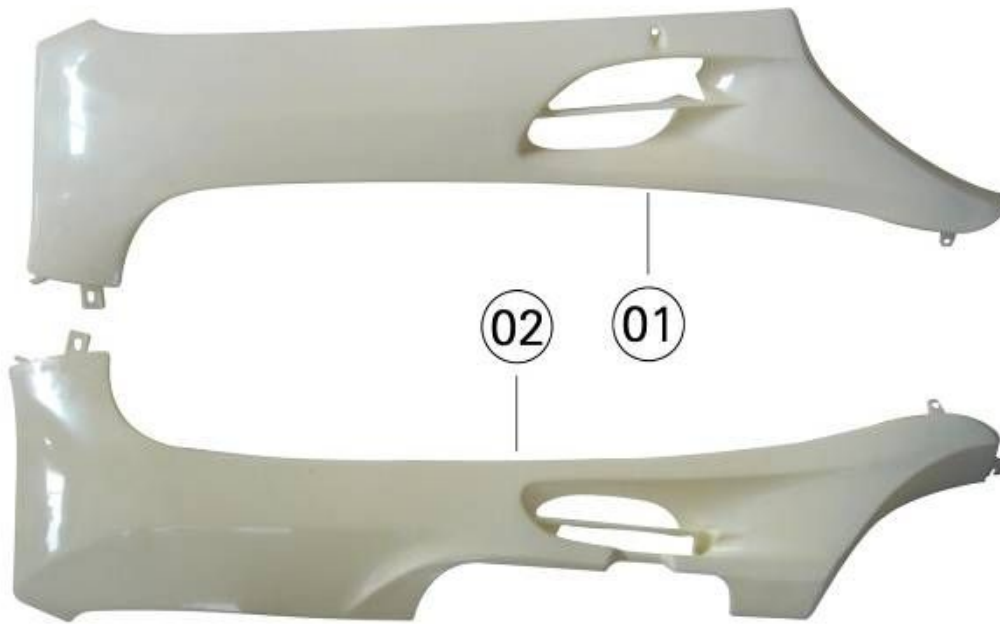

	Code	Description	Qty	Price
1	JSD250T-8-014	Right cover, Mid	1	15.00
2	JSD250T-8-015	Left cover, Mid	1	15.00

:L/R side cover



	Code	Description	Qty	Price
1	JSD250T-8-018	Right side cover, rear	1	11.00
2	JSD250T-8-019	Left side cover, rear	1	11.00

Makeup gas equipment, side glisten



	Code	Description	Qty	Price
1	JSD250T-7-00A	Makeup gas equipment	1	12.00
2	JSD250T-7-00B	Pipe vaccum	1	2/M
3	JSD250T-7-00C	Air tube	2	4/M
4	JSD250T-7-00D	Vent valve	1	2.00
5	JSD250T-7-00E	High-temperature tube	1	15/M
6	JSD250T-7-00F	Spring nut	6	0.60